

# BC639; BCP56; BCX56

80 V, 1 A NPN medium power transistor series

Rev. 07 — 8 March 2005

Product data sheet

## 1. Product profile

### 1.1 General description

NPN medium power transistor series.

Table 1: Product overview

Type number [1]	Package		PNP complement
	Philips	JEITA	
BC639 [2]	SOT54	SC-43A*	BC640
BCP56	SOT223	SC-73	BCP53
BCX56	SOT89	SC-62	BCX53

[1] Valid for all available selection groups.

[2] Also available in SOT54A and SOT54 variant packages (see [Section 2](#)).

### 1.2 Features

- High current
- Three current gain selections

### 1.3 Applications

- Linear voltage regulators
- Low side switches
- Supply line switches
- MOSFET drivers

### 1.4 Quick reference data

Table 2: Quick reference data

Symbol	Parameter	Conditions	Min	Typ	Max	Unit
$V_{CE0}$	collector-emitter voltage	open base	-	-	80	V
$I_C$	collector current (DC)		-	-	1	A
$I_{CM}$	peak collector current		-	-	1.5	A
$h_{FE}$	DC current gain	$V_{CE} = 2 \text{ V}; I_C = 150 \text{ mA}$	63	-	250	
	selection -10	$V_{CE} = 2 \text{ V}; I_C = 150 \text{ mA}$	63	-	160	
	selection -16	$V_{CE} = 2 \text{ V}; I_C = 150 \text{ mA}$	100	-	250	

**PHILIPS**

## 2. Pinning information

Table 3: Pinning

Pin	Description	Simplified outline	Symbol
<b>SOT54</b>			
1	base	<p>001aab347</p>	<p>sym056</p>
2	collector		
3	emitter		
<b>SOT54A</b>			
1	base	<p>001aab348</p>	<p>sym056</p>
2	collector		
3	emitter		
<b>SOT54 variant</b>			
1	base	<p>001aab447</p>	<p>sym056</p>
2	collector		
3	emitter		
<b>SOT223</b>			
1	base		<p>sym016</p>
2	collector		
3	emitter		
4	collector		
<b>SOT89</b>			
1	emitter		<p>sym042</p>
2	collector		
3	base		

### 3. Ordering information

**Table 4: Ordering information**

Type number <sup>[1]</sup>	Package		
	Name	Description	Version
BC639 <sup>[2]</sup>	SC-43A	plastic single-ended leaded (through hole) package; 3 leads	SOT54
BCP56	SC-73	plastic surface mounted package with increased heatsink; 4 leads	SOT223
BCX56	SC-62	plastic surface mounted package; collector pad for good heat transfer; 3 leads	SOT89

[1] Valid for all available selection groups.

[2] Also available in SOT54A and SOT54 variant packages (see [Section 2](#) and [Section 9](#)).

### 4. Marking

**Table 5: Marking codes**

Type number	Marking code
BC639	C639
BC639-10	C63910
BC639-16	C63916
BCP56	BCP56
BCP56-10	BCP56/10
BCP56-16	BCP56/16
BCX56	BH
BCX56-10	BK
BCX56-16	BL

## 5. Limiting values

**Table 6: Limiting values**

*In accordance with the Absolute Maximum Rating System (IEC 60134).*

Symbol	Parameter	Conditions	Min	Max	Unit
$V_{CBO}$	collector-base voltage	open emitter	-	100	V
$V_{CEO}$	collector-emitter voltage	open base	-	80	V
$V_{EBO}$	emitter-base voltage	open collector	-	5	V
$I_C$	collector current (DC)		-	1	A
$I_{CM}$	peak collector current		-	1.5	A
$I_{BM}$	peak base current		-	0.2	A
$P_{tot}$	total power dissipation				
	BC639	$T_{amb} \leq 25\text{ °C}$	[1] -	0.83	W
	BCP56	$T_{amb} \leq 25\text{ °C}$	[1] -	0.65	W
	BCP56	$T_{amb} \leq 25\text{ °C}$	[2] -	1	W
	BCP56	$T_{amb} \leq 25\text{ °C}$	[3] -	1.4	W
	BCX56	$T_{amb} \leq 25\text{ °C}$	[1] -	0.5	W
	BCX56	$T_{amb} \leq 25\text{ °C}$	[2] -	0.85	W
	BCX56	$T_{amb} \leq 25\text{ °C}$	[3] -	1.2	W
$T_{stg}$	storage temperature		-65	+150	°C
$T_j$	junction temperature		-	150	°C
$T_{amb}$	ambient temperature		-65	+150	°C

[1] Device mounted on an FR4 Printed-Circuit Board (PCB), single-sided copper, tin-plated and standard footprint.

[2] Device mounted on an FR4 PCB, single-sided copper, tin-plated, mounting pad for collector 1 cm<sup>2</sup>.

[3] Device mounted on an FR4 PCB, single-sided copper, tin-plated, mounting pad for collector 6 cm<sup>2</sup>.

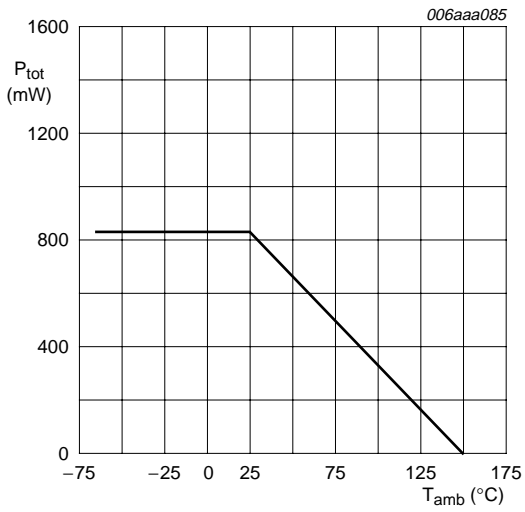

FR4 PCB; standard footprint

**Fig 1. Power derating curve; SOT54**

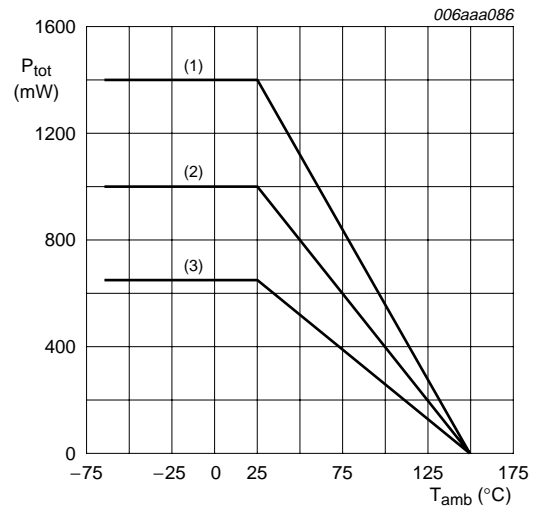

- (1) FR4 PCB; 6 cm<sup>2</sup> mounting pad for collector
- (2) FR4 PCB; 1 cm<sup>2</sup> mounting pad for collector
- (3) FR4 PCB; standard footprint

**Fig 2. Power derating curves; SOT223**

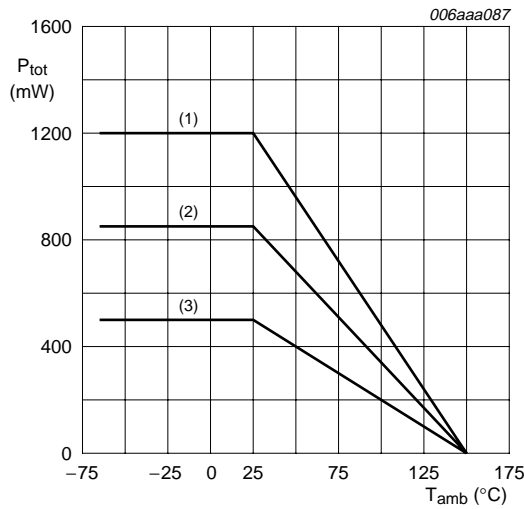

- (1) FR4 PCB; 6 cm<sup>2</sup> mounting pad for collector
- (2) FR4 PCB; 1 cm<sup>2</sup> mounting pad for collector
- (3) FR4 PCB; standard footprint

**Fig 3. Power derating curves; SOT89**

## 6. Thermal characteristics

**Table 7: Thermal characteristics**

Symbol	Parameter	Conditions	Min	Typ	Max	Unit
$R_{th(j-a)}$	thermal resistance from junction to ambient					
	BC639	$T_{amb} \leq 25\text{ °C}$	[1] -	-	150	K/W
	BCP56	$T_{amb} \leq 25\text{ °C}$	[1] -	-	192	K/W
	BCP56	$T_{amb} \leq 25\text{ °C}$	[2] -	-	125	K/W
	BCP56	$T_{amb} \leq 25\text{ °C}$	[3] -	-	89	K/W
	BCX56	$T_{amb} \leq 25\text{ °C}$	[1] -	-	250	K/W
	BCX56	$T_{amb} \leq 25\text{ °C}$	[2] -	-	147	K/W
	BCX56	$T_{amb} \leq 25\text{ °C}$	[3] -	-	104	K/W
$R_{th(j-sp)}$	thermal resistance from junction to soldering point					
	BC639	$T_{amb} \leq 25\text{ °C}$	-	-	40	K/W
	BCP56	$T_{amb} \leq 25\text{ °C}$	-	-	17	K/W
	BCX56	$T_{amb} \leq 25\text{ °C}$	-	-	30	K/W

[1] Device mounted on an FR4 PCB, single-sided copper, tin-plated and standard footprint.

[2] Device mounted on an FR4 PCB, single-sided copper, tin-plated, mounting pad for collector 1 cm<sup>2</sup>.

[3] Device mounted on an FR4 PCB, single-sided copper, tin-plated, mounting pad for collector 6 cm<sup>2</sup>.

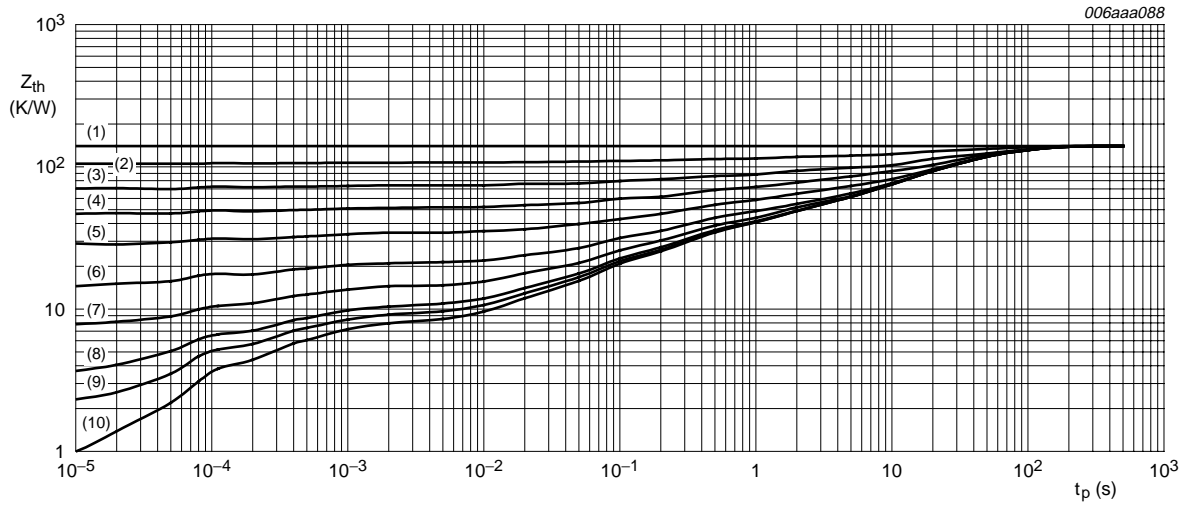

Mounted on FR4 PCB; standard footprint

- (1)  $\delta = 1$
- (2)  $\delta = 0.75$
- (3)  $\delta = 0.5$
- (4)  $\delta = 0.33$
- (5)  $\delta = 0.2$
- (6)  $\delta = 0.1$
- (7)  $\delta = 0.05$
- (8)  $\delta = 0.02$
- (9)  $\delta = 0.01$
- (10)  $\delta = 0$

**Fig 4. Transient thermal impedance as a function of pulse time for SOT54; typical values**

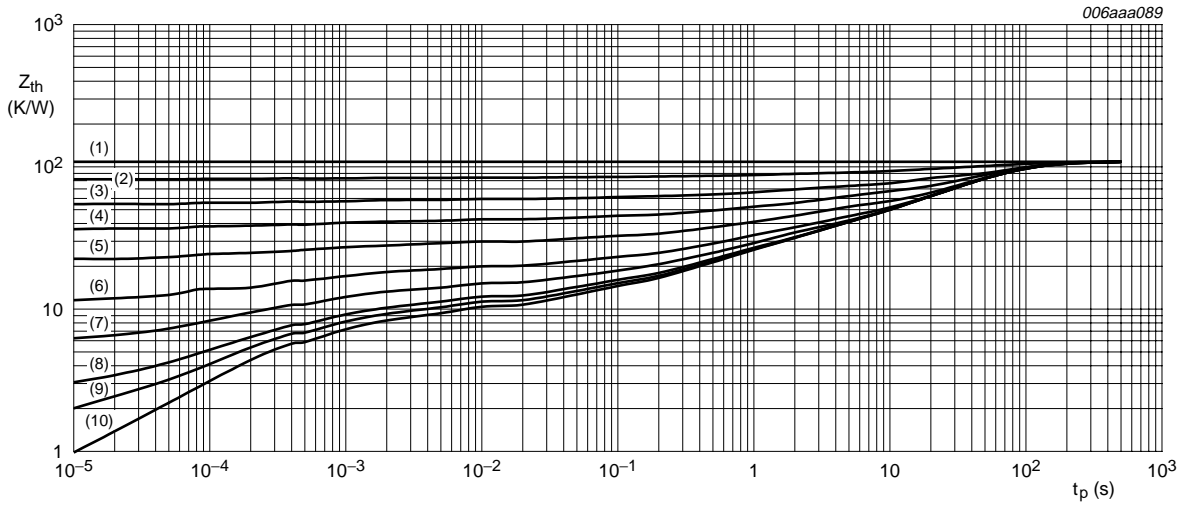

Mounted on FR4 PCB; 1 cm<sup>2</sup> collector mounting pad

- (1)  $\delta = 1$
- (2)  $\delta = 0.75$
- (3)  $\delta = 0.5$
- (4)  $\delta = 0.33$
- (5)  $\delta = 0.2$
- (6)  $\delta = 0.1$
- (7)  $\delta = 0.05$
- (8)  $\delta = 0.02$
- (9)  $\delta = 0.01$
- (10)  $\delta = 0$

**Fig 5. Transient thermal impedance as a function of pulse time for SOT223; typical values**



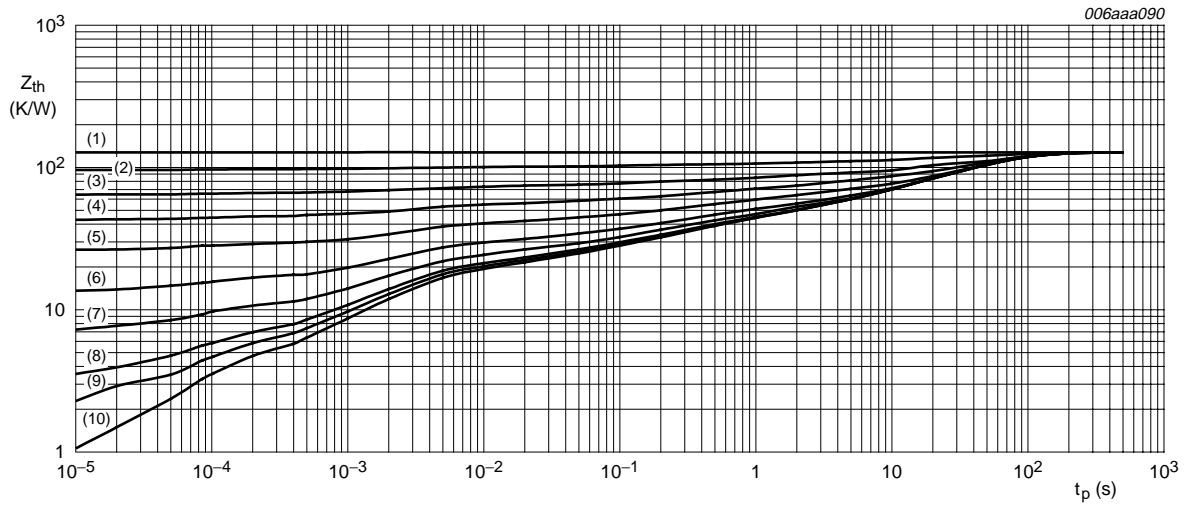

Mounted on FR4 PCB; 1 cm<sup>2</sup> collector mounting pad

- (1)  $\delta = 1$
- (2)  $\delta = 0.75$
- (3)  $\delta = 0.5$
- (4)  $\delta = 0.33$
- (5)  $\delta = 0.2$
- (6)  $\delta = 0.1$
- (7)  $\delta = 0.05$
- (8)  $\delta = 0.02$
- (9)  $\delta = 0.01$
- (10)  $\delta = 0$

**Fig 6. Transient thermal impedance as a function of pulse time for SOT89; typical values**

## 7. Characteristics

**Table 8: Characteristics**

$T_{amb} = 25\text{ }^{\circ}\text{C}$  unless otherwise specified.

Symbol	Parameter	Conditions	Min	Typ	Max	Unit
$I_{CBO}$	collector-base cut-off current	$I_E = 0\text{ A}; V_{CB} = 30\text{ V}$	-	-	100	nA
		$I_E = 0\text{ A}; V_{CB} = 30\text{ V}; T_j = 150\text{ }^{\circ}\text{C}$	-	-	10	$\mu\text{A}$
$I_{EBO}$	emitter-base cut-off current	$I_C = 0\text{ A}; V_{EB} = 5\text{ V}$	-	-	100	nA
$h_{FE}$	DC current gain	$V_{CE} = 2\text{ V}$				
		$I_C = 5\text{ mA}$	63	-	-	
		$I_C = 150\text{ mA}$	63	-	250	
		$I_C = 500\text{ mA}$	40	-	-	
	DC current gain	$V_{CE} = 2\text{ V}$				
		$h_{FE}$ selection -10	$I_C = 150\text{ mA}$	63	-	160
	$h_{FE}$ selection -16	$I_C = 150\text{ mA}$	100	-	250	
$V_{CEsat}$	collector-emitter saturation voltage	$I_C = 500\text{ mA}; I_B = 50\text{ mA}$	-	-	500	mV
$V_{BE}$	base-emitter voltage	$I_C = 500\text{ mA}; V_{CE} = 2\text{ V}$	-	-	1	V
$C_c$	collector capacitance	$I_E = i_e = 0\text{ A}; V_{CB} = 10\text{ V}; f = 1\text{ MHz}$	-	6	-	pF
$f_T$	transition frequency	$I_C = 50\text{ mA}; V_{CE} = 5\text{ V}; f = 100\text{ MHz}$	100	180	-	MHz

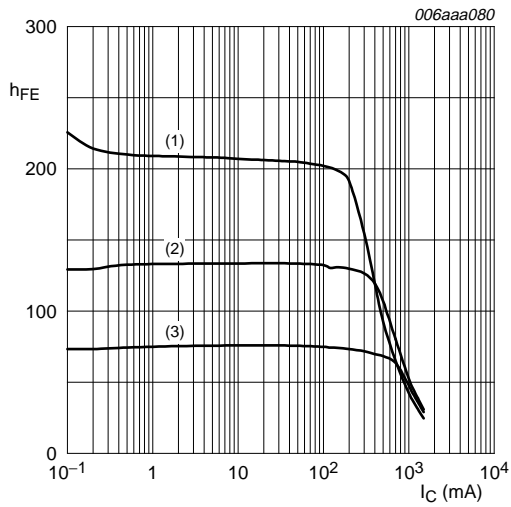

$V_{CE} = 2\text{ V}$   
 (1)  $T_{amb} = 150\text{ }^{\circ}\text{C}$   
 (2)  $T_{amb} = 25\text{ }^{\circ}\text{C}$   
 (3)  $T_{amb} = -55\text{ }^{\circ}\text{C}$

**Fig 7. DC current gain as a function of collector current; typical values**

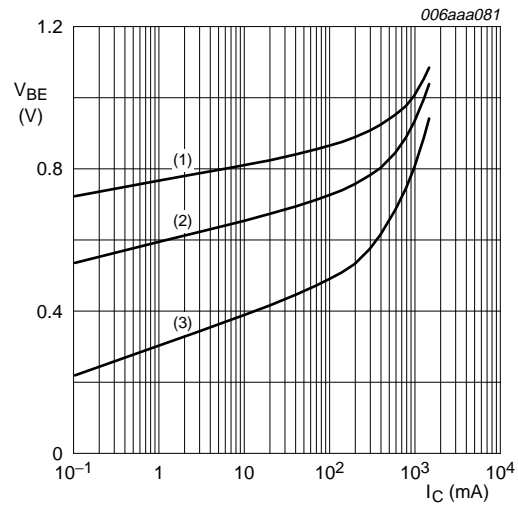

$V_{CE} = 2\text{ V}$   
 (1)  $T_{amb} = -55\text{ }^{\circ}\text{C}$   
 (2)  $T_{amb} = 25\text{ }^{\circ}\text{C}$   
 (3)  $T_{amb} = 150\text{ }^{\circ}\text{C}$

**Fig 8. Base-emitter voltage as a function of collector current; typical values**

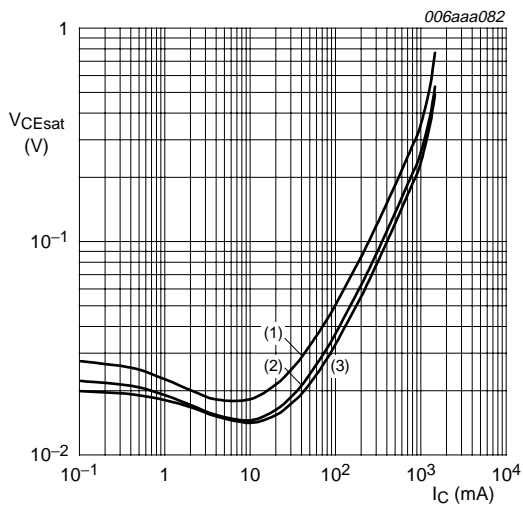

$I_C/I_B = 10$   
 (1)  $T_{amb} = 150\text{ }^{\circ}\text{C}$   
 (2)  $T_{amb} = 25\text{ }^{\circ}\text{C}$   
 (3)  $T_{amb} = -55\text{ }^{\circ}\text{C}$

**Fig 9. Collector-emitter saturation voltage as a function of collector current; typical values**

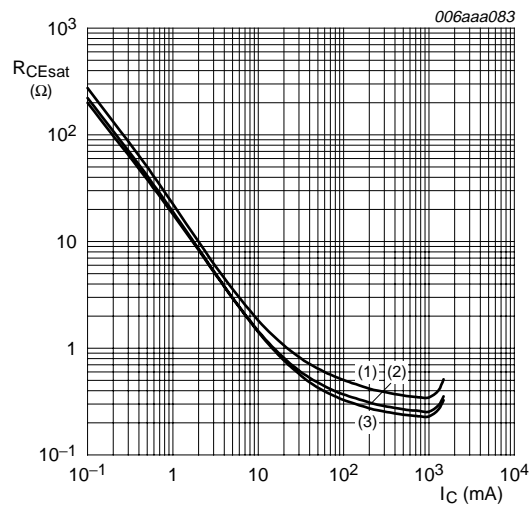

$I_C/I_B = 10$   
 (1)  $T_{amb} = 150\text{ }^{\circ}\text{C}$   
 (2)  $T_{amb} = 25\text{ }^{\circ}\text{C}$   
 (3)  $T_{amb} = -55\text{ }^{\circ}\text{C}$

**Fig 10. Equivalent on-resistance as a function of collector current; typical values**

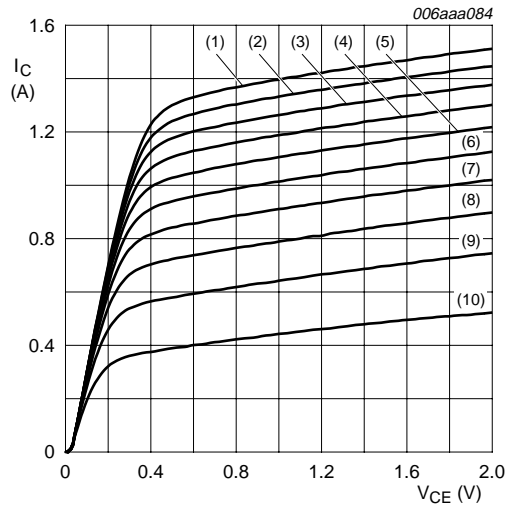

- (1) I<sub>B</sub> = 50 mA
- (2) I<sub>B</sub> = 45 mA
- (3) I<sub>B</sub> = 40 mA
- (4) I<sub>B</sub> = 35 mA
- (5) I<sub>B</sub> = 30 mA
- (6) I<sub>B</sub> = 25 mA
- (7) I<sub>B</sub> = 20 mA
- (8) I<sub>B</sub> = 15 mA
- (9) I<sub>B</sub> = 10 mA
- (10) I<sub>B</sub> = 5 mA

**Fig 11. Collector current as a function of collector-emitter voltage; typical values**

**8. Package outline**

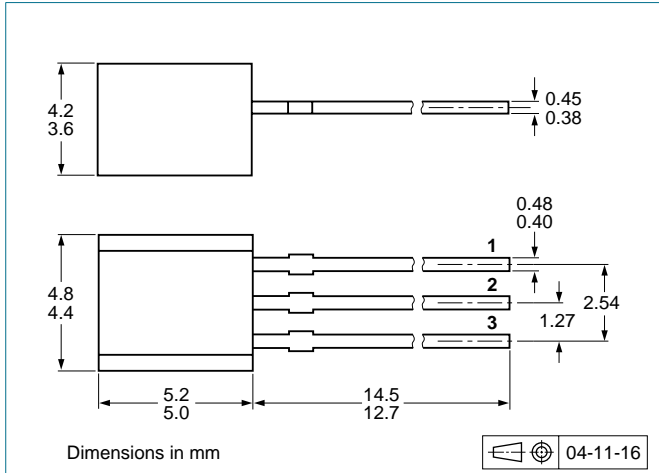

**Fig 12. Package outline SOT54 (SC-43A/TO-92)**

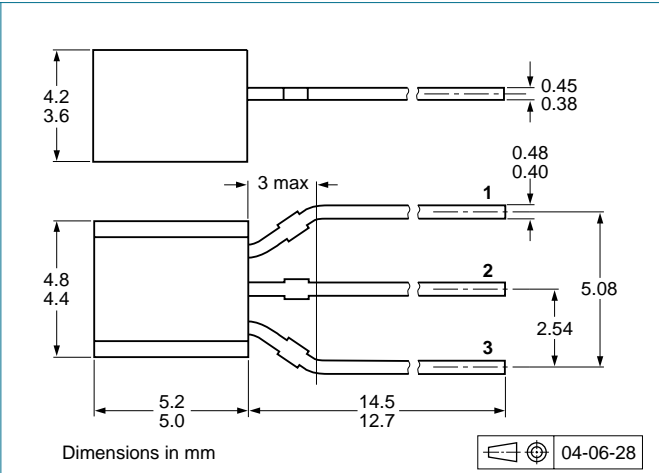

**Fig 13. Package outline SOT54A**

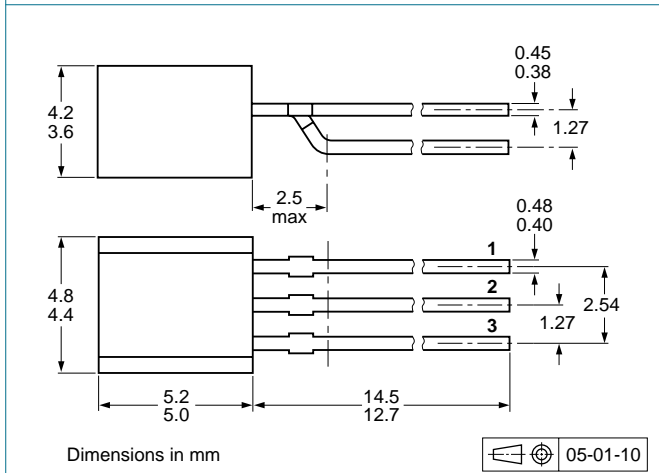

**Fig 14. Package outline SOT54 variant**

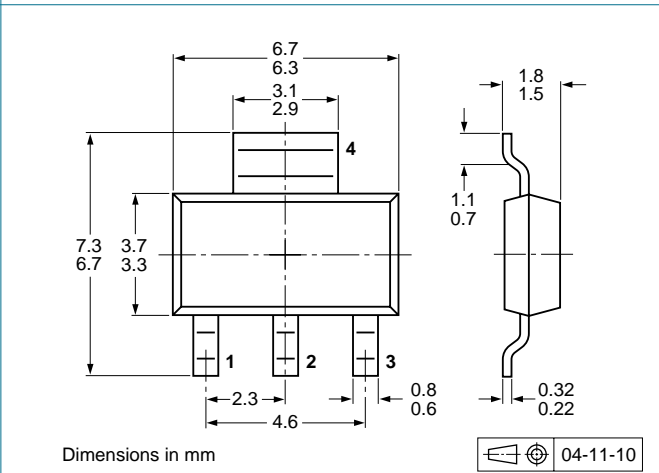

**Fig 15. Package outline SOT223 (SC-73)**

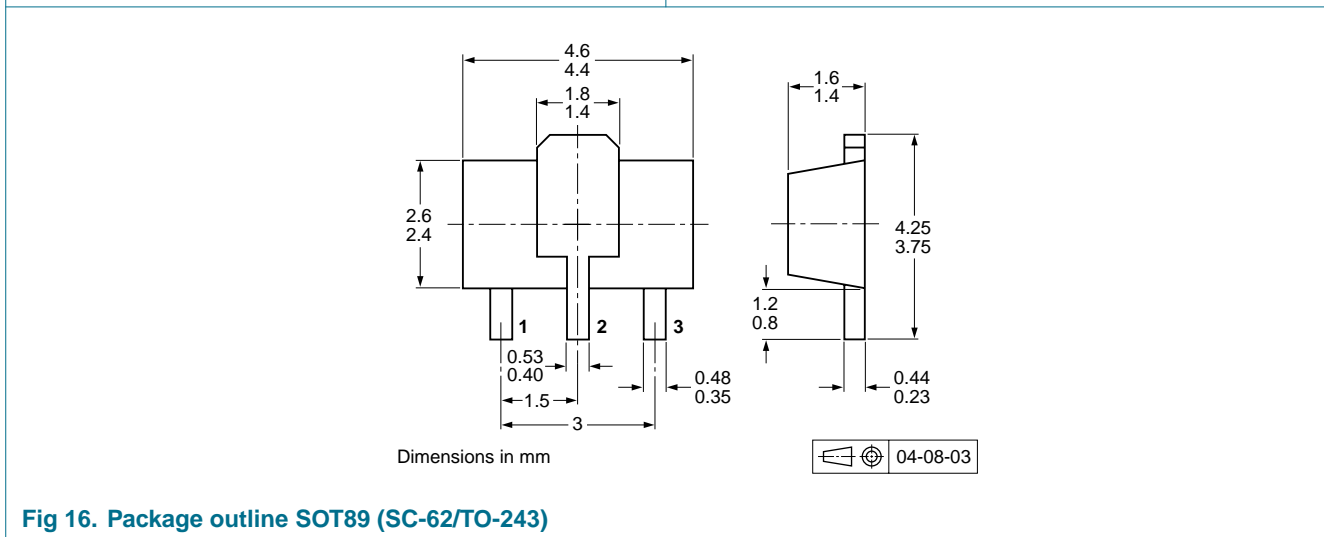

**Fig 16. Package outline SOT89 (SC-62/TO-243)**

## 9. Packing information

**Table 9: Packing methods**

The indicated -xxx are the last three digits of the 12NC ordering code. [\[1\]](#)

Type number	Package	Description	Packing quantity			
			1000	4000	5000	10000
BC639	SOT54	bulk, straight leads	-	-	-412	-
	SOT54A	tape and reel, wide pitch	-	-	-	-116
		tape ammopack, wide pitch	-	-	-	-126
	SOT54 variant	bulk, delta pinning (on-circle)	-	-	-112	-
BCP56	SOT223	8 mm pitch, 12 mm tape and reel	-115	-135	-	-
BCX56	SOT89	8 mm pitch, 12 mm tape and reel	-115	-135	-	-

[1] For further information and the availability of packing methods, see [Section 14](#).

## 10. Revision history

**Table 10: Revision history**

Document ID	Release date	Data sheet status	Change notice	Doc. number	Supersedes
BC639_BCP56_ BCX56_7	20050308	Product data sheet	-	9397 750 14863	BC639_BCP56_ BCX56_6
Modifications:	<ul style="list-style-type: none"> <li>The document IDs in the second bullet list item of the Modifications row in this table for document ID BC639_BCP56_BCX56_6 have been amended as shown.</li> </ul>				
BC639_BCP56_ BCX56_6	20050303	Product data sheet	CPCN200405029	9397 750 14042	BC635_637_639_4; BCP54_55_56_5; BCX54_55_56_4
Modifications:	<ul style="list-style-type: none"> <li>The format of this data sheet has been redesigned to comply with the new presentation and information standard of Philips Semiconductors.</li> <li>This data sheet is a combination of data sheets BC635_637_639_4, BCP54_55_56_5 and BCX54_55_56_4.</li> <li><a href="#">Figure 1</a>, <a href="#">2</a>, <a href="#">3</a>, <a href="#">4</a>, <a href="#">5</a> and <a href="#">6</a> added</li> <li><a href="#">Figure 7</a> replaced according to CPCN200405029</li> <li><a href="#">Figure 8</a>, <a href="#">9</a>, <a href="#">10</a>, <a href="#">11</a>, <a href="#">13</a> and <a href="#">14</a> added</li> <li><a href="#">Section 9 "Packing information"</a> added</li> </ul>				
BC635_637_639_4	20011010	Product specification	-	9397 750 08738	BC635_637_639_3
BCP54_55_56_5	20030206	Product specification	-	9397 750 10763	BCP54_55_56_4
BCX54_55_56_4	20011010	Product specification	-	9397 750 08744	BCX54_55_56_3

## 11. Data sheet status

Level	Data sheet status <sup>[1]</sup>	Product status <sup>[2] [3]</sup>	Definition
I	Objective data	Development	This data sheet contains data from the objective specification for product development. Philips Semiconductors reserves the right to change the specification in any manner without notice.
II	Preliminary data	Qualification	This data sheet contains data from the preliminary specification. Supplementary data will be published at a later date. Philips Semiconductors reserves the right to change the specification without notice, in order to improve the design and supply the best possible product.
III	Product data	Production	This data sheet contains data from the product specification. Philips Semiconductors reserves the right to make changes at any time in order to improve the design, manufacturing and supply. Relevant changes will be communicated via a Customer Product/Process Change Notification (CPCN).

[1] Please consult the most recently issued data sheet before initiating or completing a design.

[2] The product status of the device(s) described in this data sheet may have changed since this data sheet was published. The latest information is available on the Internet at URL <http://www.semiconductors.philips.com>.

[3] For data sheets describing multiple type numbers, the highest-level product status determines the data sheet status.

## 12. Definitions

**Short-form specification** — The data in a short-form specification is extracted from a full data sheet with the same type number and title. For detailed information see the relevant data sheet or data handbook.

**Limiting values definition** — Limiting values given are in accordance with the Absolute Maximum Rating System (IEC 60134). Stress above one or more of the limiting values may cause permanent damage to the device. These are stress ratings only and operation of the device at these or at any other conditions above those given in the Characteristics sections of the specification is not implied. Exposure to limiting values for extended periods may affect device reliability.

**Application information** — Applications that are described herein for any of these products are for illustrative purposes only. Philips Semiconductors make no representation or warranty that such applications will be suitable for the specified use without further testing or modification.

## 13. Disclaimers

**Life support** — These products are not designed for use in life support appliances, devices, or systems where malfunction of these products can reasonably be expected to result in personal injury. Philips Semiconductors customers using or selling these products for use in such applications do so at their own risk and agree to fully indemnify Philips Semiconductors for any damages resulting from such application.

**Right to make changes** — Philips Semiconductors reserves the right to make changes in the products - including circuits, standard cells, and/or software - described or contained herein in order to improve design and/or performance. When the product is in full production (status 'Production'), relevant changes will be communicated via a Customer Product/Process Change Notification (CPCN). Philips Semiconductors assumes no responsibility or liability for the use of any of these products, conveys no license or title under any patent, copyright, or mask work right to these products, and makes no representations or warranties that these products are free from patent, copyright, or mask work right infringement, unless otherwise specified.

## 14. Contact information

For additional information, please visit: <http://www.semiconductors.philips.com>

For sales office addresses, send an email to: [sales.addresses@www.semiconductors.philips.com](mailto:sales.addresses@www.semiconductors.philips.com)



## 15. Contents

<b>1</b>	<b>Product profile</b> . . . . .	<b>1</b>
1.1	General description . . . . .	1
1.2	Features . . . . .	1
1.3	Applications . . . . .	1
1.4	Quick reference data . . . . .	1
<b>2</b>	<b>Pinning information</b> . . . . .	<b>2</b>
<b>3</b>	<b>Ordering information</b> . . . . .	<b>3</b>
<b>4</b>	<b>Marking</b> . . . . .	<b>3</b>
<b>5</b>	<b>Limiting values</b> . . . . .	<b>4</b>
<b>6</b>	<b>Thermal characteristics</b> . . . . .	<b>6</b>
<b>7</b>	<b>Characteristics</b> . . . . .	<b>10</b>
<b>8</b>	<b>Package outline</b> . . . . .	<b>13</b>
<b>9</b>	<b>Packing information</b> . . . . .	<b>14</b>
<b>10</b>	<b>Revision history</b> . . . . .	<b>15</b>
<b>11</b>	<b>Data sheet status</b> . . . . .	<b>16</b>
<b>12</b>	<b>Definitions</b> . . . . .	<b>16</b>
<b>13</b>	<b>Disclaimers</b> . . . . .	<b>16</b>
<b>14</b>	<b>Contact information</b> . . . . .	<b>16</b>



© Koninklijke Philips Electronics N.V. 2005

All rights are reserved. Reproduction in whole or in part is prohibited without the prior written consent of the copyright owner. The information presented in this document does not form part of any quotation or contract, is believed to be accurate and reliable and may be changed without notice. No liability will be accepted by the publisher for any consequence of its use. Publication thereof does not convey nor imply any license under patent- or other industrial or intellectual property rights.

Date of release: 8 March 2005  
Document number: 9397 750 14863

Published in The Netherlands